

**SKYRC** 

# INSTRUCTION MANUAL

## *Touch System*

# **T6200**

TOUCH SENSITIVE  
**3.2"** (320x240 dot)  
COLOR LCD SCREEN



# **12 200Watt AMP**

**Professional Balance Charger / Discharger  
Battery Meter / Motor RPM Tester / Servo Tester**

Manufactured by  
**SKYRC TECHNOLOGY CO., LTD.**  
www.skyrc.com

All specifications and figures are subject to change without notice.  
Printed in China ©2013  
7504-0347-01



**SKYRC** 

Version 1.01

INTRODUCTION .....	01
MAIN FEATURES .....	03
WARNING AND SAFETY NOTES.....	05
HOME PAGE .....	07
OPERATION PROGRAM .....	08
CHARGING STATUS MONITOR .....	14
USING THE CHARGE CONTROL SOFTWARE “CHARGE MASTER” .....	14
BATTERY METER .....	15
MOTOR RPM TESTER.....	16
SERVO TESTER.....	17
MEMORY PRESET-DATA STORE/LOAD.....	18
SETTING .....	19
ERROR MESSAGE.....	21
SPECIFICATION .....	22
RECOMMENDED ACCESSORIES .....	23
CONFORMITY DECLARATION AND LIABILITY EXCLUSION .....	24
WARRANTY AND SERVICE.....	24

## INTRODUCTION

Congratulations on your choice of the SKYRC T6200 Professional Balance Charger/ Discharger Battery Meter / Motor RPM Tester / Servo Tester from SKYRC Technology Co., Ltd. This unit is simple to use, but the operation of a sophisticated automatic charger such as SKYRC T6200 does require some knowledge on the part of the user. These operating instructions are designed to ensure that you quickly become familiar with its functions. It is therefore important that you read right through the Operating Instructions, Warning and Safety Notes before you attempt to use your new charger for the first time. We hope you have many years of pleasure and success with your new battery charger.

SKYRC T6200 represents the newest technology of chargers with its advanced touch system. As it is a “touch” charger, of course the screen plays an important role in this system. We equip it with a 3.2” (320\*240 dot) touch sensitive color LCD screen. It is intuitive as all the operating instruction and changing status can be displayed in this screen and the touch screen can register the users' input precisely so that the users can have a wonderful and comfortable “touch” experience.

When the charger is working, the users could check the information of charging capacity, cell voltage, charging time, external and internal temperature easily. What's more, it can also display the voltage in a graphic which helps the user monitor the charging status all the time.

SKYRC T6200 is a high-performance, micro processor control charge/discharge station with battery management suitable for use with all current battery types. With integral equalizer for six-cell Lithium- Polymer (LiPo), Lithium-Ferrum (LiFe) and Lithium-Ion (Lilon) batteries; maximum 12A charge current; maximum 200W charge power. It can be powered by a 12V car battery or a high quality AC-DC power supply in the range of 12V to 18V DC output, with minimum current rating of 20A to insure reliable performance.

When a NiMH/NiCd battery is fully charged, the unit terminates the process using the Delta-Peak method. Lithium and lead (Pb) batteries are charged using the CC-CV method.

The fan cooling system is so smart and efficient. The fan speed is controlled by internal temperature sensor.

It also adds lithium Battery Volt Meter, Motor RPM Tester and Servo Tester functions. It is convenient for user to get some useful information with this charger.

Please BE SURE to read these INSTRUCTIONS, WARNING and SAFETY NOTES before you use the charger for the first time.

It can be dangerous to mis-handle batteries and battery chargers, as there is always a risk of batteries catching fire and exploding.

Please read this entire operating manual completely and attentively before using this product, as it covers a wide range of information on operating and safety. Or please do use this product in company with a specialist!

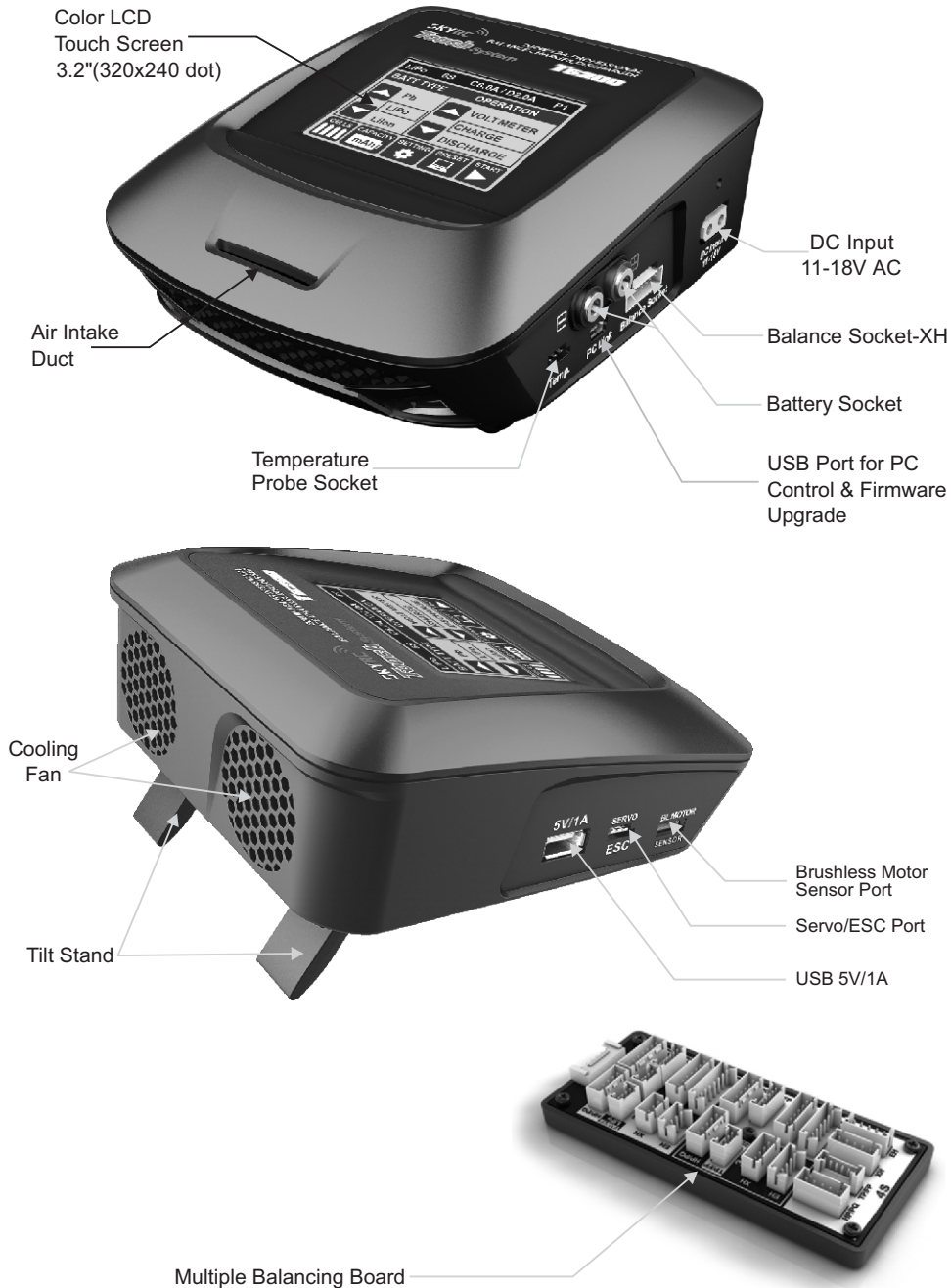

**FEATURES**

**Touch System**

Equipped with a 3.2" touch sensitive color LCD screen, it is intuitive as all the operating and changing status can be displayed in this screen. What's more, the touch screen can register the users' input precisely so that the users can have a wonderful and comfortable "touch" experience.

**Optimized Operating Software**

SKYRC T6200 Charger features the so-called AUTO function that set the feeding current during the process of charging or discharging. Especially for lithium batteries, it can prevent the overcharging which may lead to an explosion due to the user's fault. It can disconnect the circuit automatically and alarm once detecting any malfunction. All the programs of this product were controlled through two way linkage and communication, to achieve the maximum safety and minimize the trouble. All the settings can be configured by users!

**Charging Status Monitor**

When the charger is working, the users could check the information of charging capacity, cell voltage, charging time, external and internal temperature easily. What's more, it can also display the voltage in a graphic which helps the user monitor the charging status all the time.

**Internal Independent Lithium Battery Balancer**

SKYRC T6200 Charger employs an individual-cell-voltage balancer. It isn't necessary to connect an external balancer for balance charging.

**Balancing Individual Cells Battery Discharging**

During the process of discharging, SKYRC T6200 Charger can monitor and balance each cell of the battery individually. Error message will be indicated and the process will be ended automatically if the voltage of any single one cell is abnormal.

**Adaptable to Various Type of Lithium Battery**

SKYRC T6200 Charger is adaptable to various types of lithium batteries, such as LiPo, Lilon and the new LiFe series of batteries.

**Fast and Storage Mode of Lithium Battery**

Purposes to charge lithium battery varies, 'fast' charge reduce the duration of charging, whereas 'store' state can control the final voltage of your battery, so as to store for a long time and protect useful time of the battery.

**Cyclic Charging/Discharging**

1 to 5 cyclic and continuous process of charge>discharge or discharge > charge is operable for battery refreshing and balancing to stimulate the battery's activity.

**Memory Preset**

The charger can store up to 5 different charge/discharge profiles for your convenience. You can keep the data pertaining to program setting of the battery of continuous charging or discharging. Users can call out these data at any time without any special program setting.

**Terminal Voltage Control (TVC)**

The charger allows user to set the charge/discharge end voltage.

**Battery Volt Meter**

The user can check Lithium battery's total voltage, the highest voltage, the lowest voltage and each cell's voltage; and can check Nickel and Pb battery's total voltage.

## Motor RPM Tester

Users connect the sensor motor and charger with sensor wire, set the pulse width and test the RPM of the motor.

## Servo Tester

Connect the servo and the charger with wire, change the pulse width value and check whether the servo works or not.

## Re-Peak Mode of NiMH/NiCd Battery

In re-peak charge mode, the charger can peak charge the battery once, twice or three times in a row automatically. This is good for making certain the battery is fully charged, and for checking how well the battery receives fast charges.

## Delta-peak Sensitivity for NiMH/NiCd

Delta-peak sensitivity for NiMH/NiCd battery: The automatic charge termination program based on the principle of the delta-peak voltage detection. When the battery's voltage exceeds the threshold, the process will be terminated automatically.

## Automatic Charging Current Limit

You can set up the upper limit of the charging current when charging your NiMH or NiCd battery, it is useful for the NiMH battery of low impedance and capacity in the 'AUTO' charging mode.

## Capacity Limit

The charging capacity is always calculated as the charging current multiplied by time. If the charging capacity exceeds the limit, the process will be terminated automatically when you set the maximum value.

## Temperature Threshold\*

The battery's internal chemical reaction will cause the temperature of the battery to rise. If the temperature limit is reached, the process will be terminated.

## Processing Time Limit

You can also limit the maximum process time to avoid any possible defect

## PC Control Software "Charge Master"\*\*\*

There is a mini USB port in the charger which can be used to connect it to the PC. You need optional USB cable (USB A Male to Mini B Male) which is not included in the package. The free "Charge Master" software gives you unparalleled ability to operate the charger through your computer. You can monitor pack voltage, cell voltage and other data during the charging, view charge date in real-time graphs. And you can initiate, control charging and update firmware from "Charge Master".

When your charger is connected to computer, the "Charger Master" takes over the control of charger. You can control and operate the charger via the "Charger Master" only.

## Multi-Language and Four Color Theme Optional

There are two languages and four kinds of color theme stored in the charger and users could select the display language and color theme as basing on personal preference.

## Inner resistance of battery pack

Measure Inner resistance of battery pack inclusively all connectors and leads.

\* This function is available by connecting optional temperature probe which is not included in the package.

\*\* Users can control and monitor the charge through computer when **Charge Master** software is installed.  
You can download **Charge Master** software from our website [www.skyrc.com](http://www.skyrc.com)

## WARNING AND SAFETY NOTES

These warnings and safety notes are particularly important. Please follow the instructions for maximum safety; otherwise the charger and the battery can be damaged or at worst it can cause a fire.



- ⚠ Never leave the charger unattended when it is connected to its power supply. If any malfunction is found, TERMINATE THE PROCESS AT ONCE and refer to the operation manual.
- ⚠ Keep the charger well away from dust, damp, rain, heat, direct sunshine and vibration. Never drop it.
- ⚠ The allowable DC input voltage is 11-18V DC.
- ⚠ This charger and the battery should be put on a heat-resistant, non-flammable and non-conductive surface. Never place them on a car seat, carpet or similar surface. Keep all flammable volatile materials away from the operating area.
- ⚠ Make sure you know the specifications of the battery to be charged or discharged to ensure it meets the requirements of this charger. If the program is set up incorrectly, the battery and charger may be damaged. Fire or explosion can occur due to overcharging. This warranty is not valid for any damage or subsequent damage arising as a result of a misuse or failure to observe the procedures outlined in this manual.
- ⚠ To avoid short circuiting between the charge lead, always connect the charge cable to the charger first, then connect the battery. Reverse the sequence when disconnecting.
- ⚠ Never attempt to charge or discharge the following types of batteries:
  - A battery pack which consists of different types of cells (including different manufacturers)
  - A battery that is already fully charged or just slightly discharged
  - Non-rechargeable batteries (pose an explosion hazard)
  - A faulty or damaged battery
  - A battery fitted with an integral charge circuit or a protection circuit
  - Batteries installed in a device or which are electrically linked to other components
  - Batteries that are not expressly stated by the manufacturer to be suitable for the currents the charger delivers during the charge process
- ⚠ **Please bear in mind the following points before commencing charging:**
  - Did you select the appropriate program suitable for the type of battery you are charging?
  - Did you set up adequate current for charging or discharging?
  - Have you checked the battery voltage? Lithium battery packs can be wired in parallel and in series, i.e. a 2-cell pack can be 3.7V (in parallel) or 7.4V (in series).
  - Have you checked that all connections are firm and secure? Make sure there are no intermittent contacts at any point in the circuit.

## Standard Battery Parameters

	LiPo	Lilon	LiFe	NiCd	MiMH	Pb
Nominal Voltage	3.7V/cell	3.6V/cell	3.3V/cell	1.2V/cell	1.2V/cell	2.0V/cell
Max Charge Voltage	4.2V/cell	4.1V/cell	3.6V/cell	1.5V/cell	1.5V/cell	2.46V/cell
Storage Voltage	3.8V/cell	3.7V/cell	3.3V/cell	n/a	n/a	n/a
Min. Discharge Voltage	3.0-3.3V/cell	2.9-3.2V/cell	2.6-2.9V/cell	0.1-1.1V/cell	0.1-1.1V/cell	1.8V/cell

Be very careful to choose the correct voltage for different types of battery otherwise you may cause damage to the batteries. Incorrect settings could cause the cells to fire or explode.

## ⚠ Charging

During charge process, a specific quantity of electrical energy is fed into the battery. The charge quantity is calculated by multiplying charge current by charge time. The maximum permissible charge current varies depending on the battery type or its performance, and can be found in the information by the battery manufacturer. Only batteries that are expressly stated to be capable of quick-charge are allowed to be charged at rates higher than the standard charge current.

Connect the battery to the terminal of the charger: red is positive and black is negative. Due to the difference between resistance of cable and connector, the charger can not detect resistance of the battery pack, the essential requirement for the charger to work properly is that the charge lead should be of adequate conductor cross-section, and high quality connectors which are normally gold-plated should be fitted to both ends.

Always refer to the manual by the battery manufacturer pertaining to charging methods. Operate according to their recommended charging current and charging time. lithium batteries, in particular, should be charged strictly according to the manufacturer's instruction.

Close attention should be paid to the connection of lithium batteries.

Do not attempt to disassemble the battery pack arbitrarily.

Please get highlighted that lithium battery packs can be wired in parallel and in series. In the parallel connection, the battery's capacity is calculated by multiplying single the battery's capacity by the number of cells, bearing in mind that total voltage stays the same. If the voltage is imbalanced, it may cause a fire or explosion. Lithium batteries are recommended to charge in series.

## ⚠ Discharging

The main purpose of discharging is to clean the residual capacity of the battery, or to reduce the battery' voltage to a defined level. The same attention should be paid to the discharging process as the charging process. The final discharge voltage should be set up correctly to avoid deep discharging. Lithium batteries cannot be discharged to lower than the minimum voltage, or it will cause a rapid loss of capacity or a total failure. Generally, lithium batteries don't need to be discharged. Please pay attention to the minimum voltage of lithium batteries to protect them.

Some rechargeable batteries have a memory effect. If they are partly used and recharged before the whole charge is accomplished, they remember this and will only use that part of their capacity next time. This is a 'memory effect' It is said that NiMH and NiCd batteries are suffering from memory effect. NiCd has more 'memory effect' than NiMH.

Lithium batteries are recommended to be discharged partially rather than fully. Frequent full discharging should be avoided if possible. Instead, charge the battery more often or use a battery of larger capacity. Full capacity cannot be reached until it has been subjected to 10 or more charge cycles. The cyclic process of charge and discharge will optimize the capacity of battery pack.

## HOMEPAGE

When you power on the charger, you will see following screen. That is the homepage of the system.

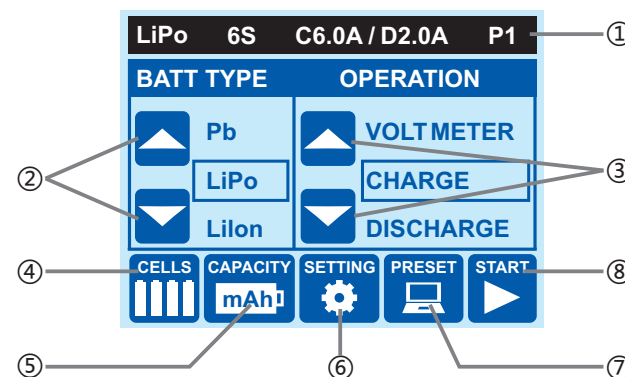

- ① It indicates the current settings(battery type / battery cells / charge current/discharge current).
- ② Batt Type - Battery Type selection button
- ③ Operation - Operation Program selection button
- ④ Cells - Battery Pack Cells number selection button
- ⑤ Battery Capacity & Charge/Discharge Current selection button
- ⑥ Setting –System setting, safety protection and charger parameter settings are here.
- ⑦ Memory Preset –5 different charge/discharge profiles are stored here.
- ⑧ Start button

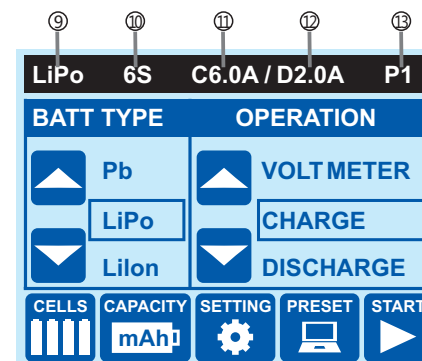

- ⑨ Battery type: LiPo/Lilon/LiFe/NiMH/NiCd/Pb
- ⑩ Battery cells
- ⑪ Charging current (0.1-12.0A)
- ⑫ Discharging current (0.1-5.0A)
- ⑬ No. of preset (P1-P5)

## OPERATION PROGRAM

### How to operate the charger?

Browse - Touch the arrow ▲ and ▼ or ◀ and ▶ to browse all the selections

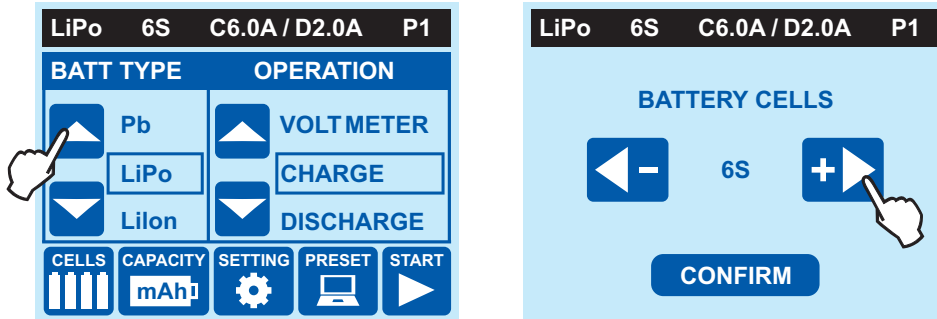

Confirm – Touch your selection on the screen to for confirmation

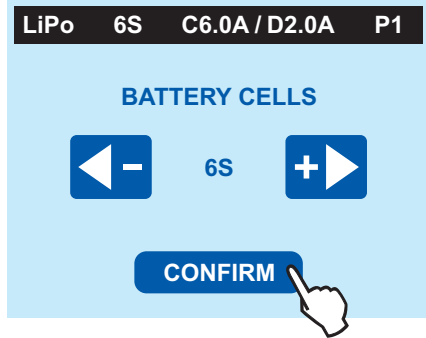

Start – Touch start button  or touch and hold the operation program for 3 seconds to start the program.

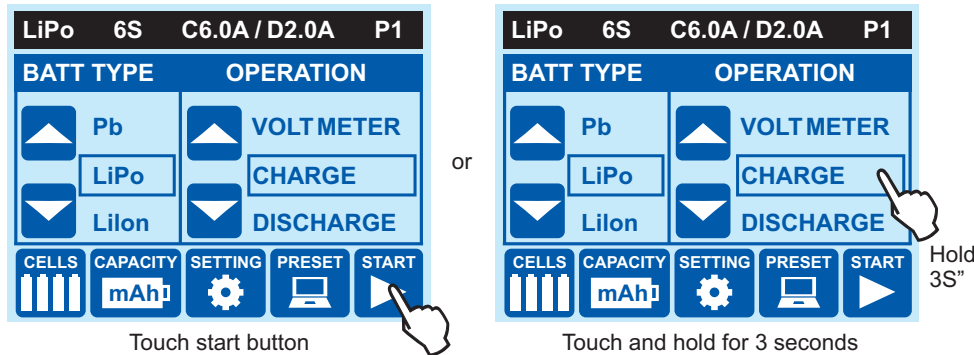

Here are the detailed procedures to make the charger work. All the screens and operations will take LiPo-CHARGE program for example,

### 1.Connection

#### 1).Connecting to Power Source

Please connect SKYRC T6200 charger with AC/DC power supply by supplied DC input cable(XT60 connectors attaching to charger and banana plugs attaching to power supply).

Also you could use terminal clips with matching XT60 female connectors, for attaching directly to 12V car batteries.

It is critically important that you use either a fully charged 13.8V car battery or a high quality AC-DC power supply in the range of 12V to 18V DC output, with minimum current rating of 20A to insure reliable performance.



Using terminal clip attaching to car battery

#### 2).Connecting The Battery

Important!!!Before connecting a battery it is absolutely essential to check one last time that you have set the parameters correctly. If the settings are incorrect, the battery may be damaged, and could even burst into flames or explode. To avoid short circuits between the banana plugs, always connect the charge leads to the charger first, and only then to the battery. Reverse the sequence when disconnecting the pack.

#### 3).Balance Socket

The balance wire attached to the battery must be connected to the charger with the blackwire aligned with the negative marking. Take care to maintain correct polarity! (See the wiring diagram below.)

This diagram shows the correct way to connect your battery to the SKYRC T6200 while charging in the balance charge program mode only.

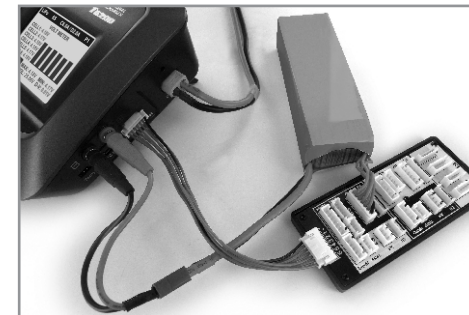

#### WARNING:

 Failure to connect as shown in this diagram will damage this charger.

## 2. Battery Setting

There are 3 basic parameter settings you have to set according to your battery. They are battery type, battery cells and battery capacity.

### 1). Battery type

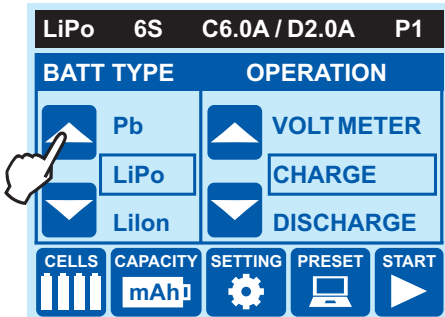

Please touch the arrow ▲ and ▼ to browse six kinds of battery types and find the right battery type. And the selected one will be framed.

### 2). Cells

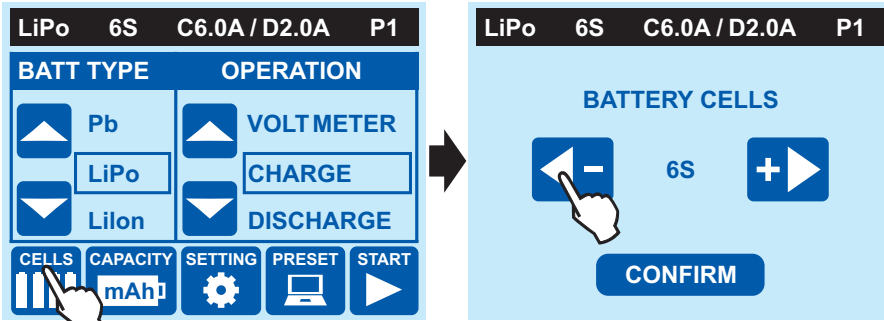

Please touch the arrow ◀ and ▶ to select the right battery cells count and touch "CONFIRM" for confirmation.

### 3). Battery Capacity & Current

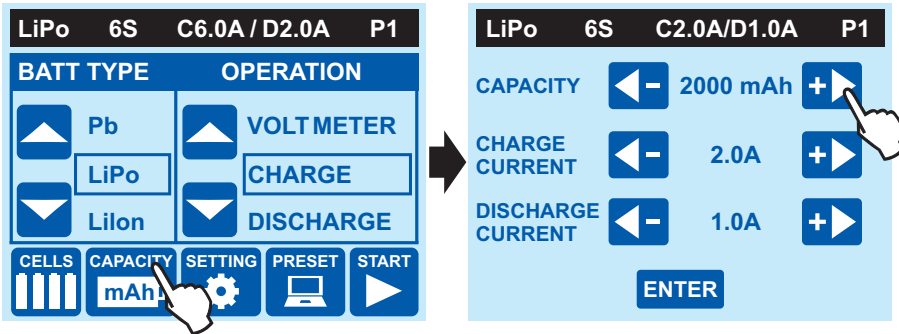

Please touch the arrow ◀ and ▶ to select the proper battery capacity and until it matches your battery.

If your battery is 850mAh, for example, you could set this to 800mAh. The default Charge Rate for lithium is 1C of capacity (equal to 0.8A for a 800mAh setting). But

allowed Max Rate is adjustable independently, so the Battery Capacity setting mainly provides additional safety monitoring.

Touch the arrow ◀ and ▶ to select the charge/discharging current if you want to modify. CAUTION! BE SURE you know what Charge/Discharge Current setting to use for your battery.

## 3. Charging Program

Depends on different battery type, the operation programs are different.

Batt Type	Operation Program	Description
LiPo Lilon LiFe	CHARGE	This charging mode is for charging LiPo/LiFe/Lilon battery in normal mode.
	DISCHARGE	This mode is for discharging LiPo/LiFe/Lilon battery.
	STORAGE	This program is for charging or discharging lithium battery which will not be used for long time.
	FAST CHG	The charging capacity may be a bit smaller than normal charging but the process time will be reduced.
	BAL CHARGE	This mode is for balancing the voltage of lithium-polymer battery cells while charging. <b>Note: We recommend charging lithium batteries with a balance wire in the balance mode only.</b>
	VOLT METER	The user can check lithium battery's total voltage, the highest voltage, the lowest voltage and each cell's voltage.
NiMH NiCd	CHARGE	The charger will charge NiMH and NiCd batteries using the charge current set by the user.
	AUTO CHG	In this program the charger detects the condition of the battery which is connected to the output and automatically charges the battery. <b>Note: you should set up the upper limit of the charge current to avoid damage by excessive feeding current. Some batteries of low resistance and capacity can lead to higher current.</b>
	DISCHARGE	This mode is for discharging NiMH/NiCd battery.
	RE-PEAK	In re-peak charge mode, the charger can peak charge the battery once, twice or three times in a row automatically. This is good for confirming the battery is fully charged, and for checking how well the battery receives fast charges.
	CYCLE	1 to 5 cyclic and continuous process of charge>discharge or discharge>charge is operable for battery refreshing and balancing to stimulate the battery's activity.
	VOLT METER	The user can check Nickel battery's total voltage.
Pb	CHARGE	This mode is for charging Pb battery.
	DISCHARGE	This mode is for discharging Pb battery.
	VOLT METER	The user can check Pb battery's total voltage.

Please touch the arrow ▲ and ▼ to find the desired operation program and the selected one will be framed.

## 4. Program Start

Touch start button or touch and hold the framed operation program for 3 seconds to start the program.

And the charger will detect battery cells automatically. If the detecting result and your setting are identical, the charger will start working automatically.

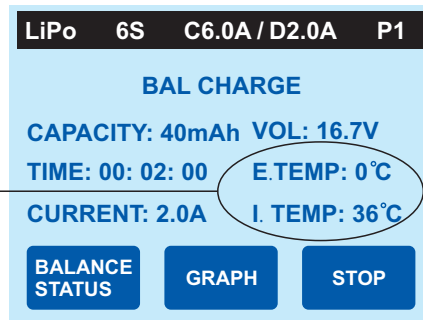
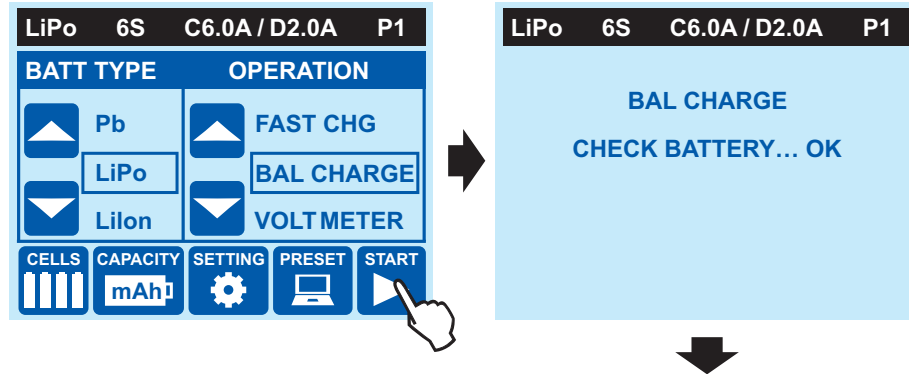

E.TEMP=External Temperature (Battery Temperature)  
Temperature probe must be attached to the charger  
I.TEMP=Charger's Internal Temperature

If the setting is wrong, it will show the error message which is not matching your battery parameter and you have to touch HOME to back to homepage to re-set the parameter before going ahead.

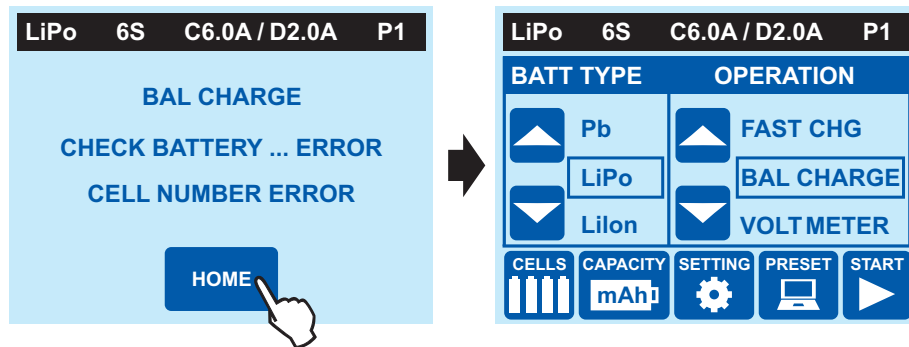

## 5. Program Stop

In charging/discharging progress, touch "STOP" to stop the progress and back to homepage.

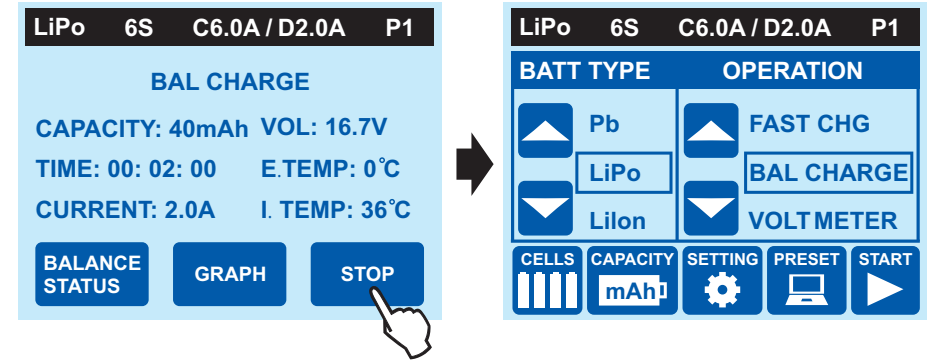

## 6. Program Complete

When the program progress is finished, the information will be displayed in the screen and an audible sound will be heard which indicates the end of the progress.

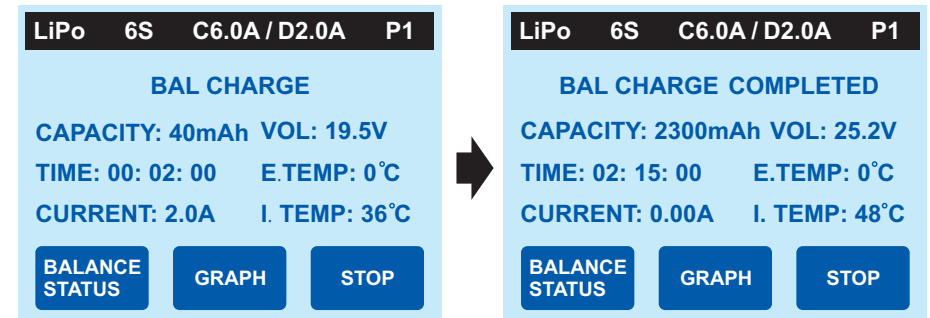



## CHARGING STATUS MONITOR

When the charger is working, the users could check the real time status of charging capacity, cell voltage, charging time, external and internal temperature easily. What's more, it can also display the voltage in a graphic which helps the user monitor the charging status all the time. Please touch "GRAPH" to check charging/discharging curve.

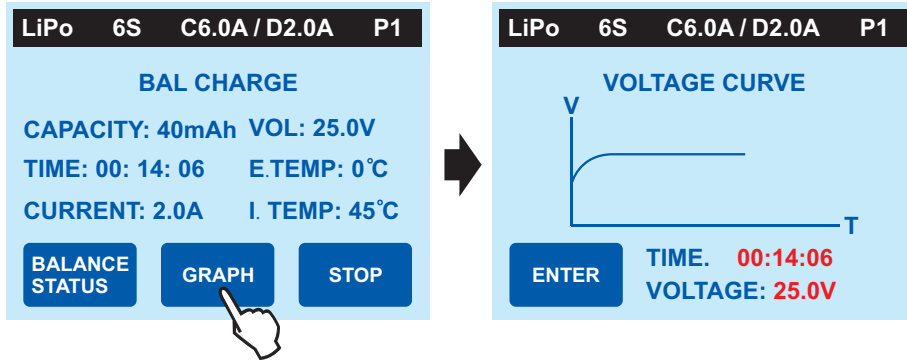

Note: When charging Lithium batteries in balance mode, you could check the balance status and internal resistance of battery pack.

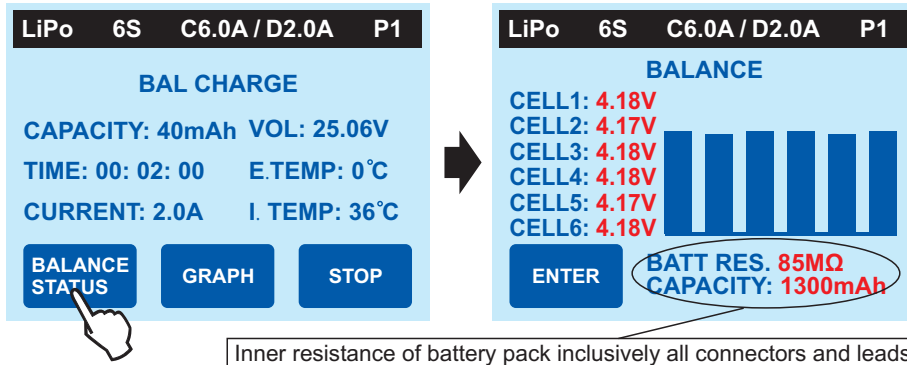

Inner resistance of battery pack inclusively all connectors and leads.

## USING THE CHARGE CONTROL SOFTWARE "CHARGE MASTER"

The free "Charge Master" software gives you unparalleled ability to operate the charger through the computer. You can monitor pack voltage, cell voltage and other data during the charging process, view charging data in real-time graphs. And you can initiate, control charging and update firmware from "Charge Master".

In order to connect the charger to the computer and use the "Charge Master", you are required to use a USB cable which is not included in this package. The cable must be terminated on one end with "A" plug and the opposite end is terminated with "mini-B" plug which can connect to the charger directly.

The "Charge Master" can be download from [www.skyrc.com](http://www.skyrc.com). For more details, please refer to HELP file which can be found in "Charge Master" software.

## BATTERY VOLT METER

The user can check lithium battery's total voltage, the highest voltage, the lowest voltage and each cell's voltage; and can check Nickel and Pb battery's total voltage.

Touch start button or touch and hold "Volt Meter" for 3 seconds to enter voltage meter program.

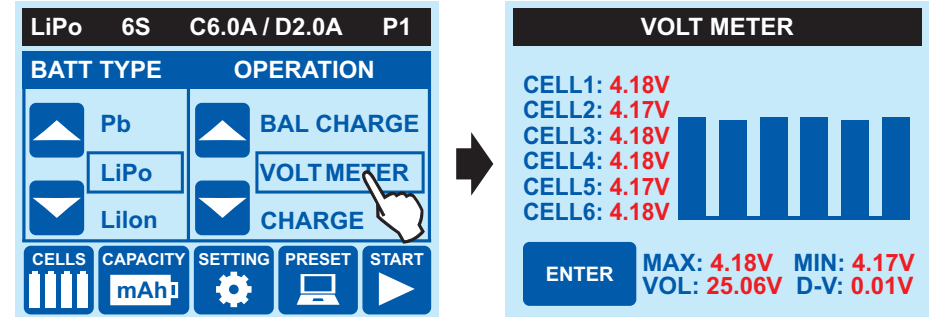

Concerning to Lithium battery, please connect the battery to the charger main battery lead to battery socket and balance wires to balance socket.

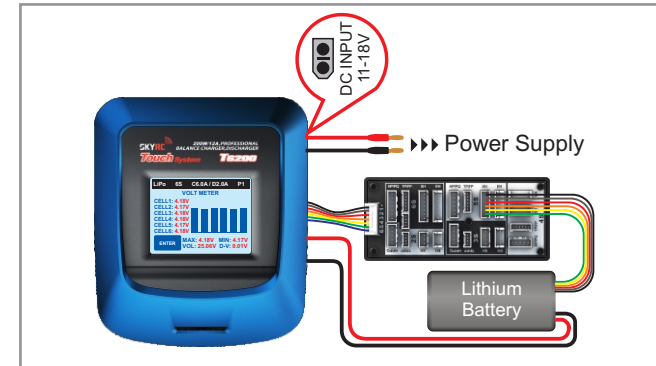

This diagram shows the correct way to connect your battery to check the voltage.

Concerning to Nickel and Pb battery, you could connect it directly to the charger to check the total voltage.

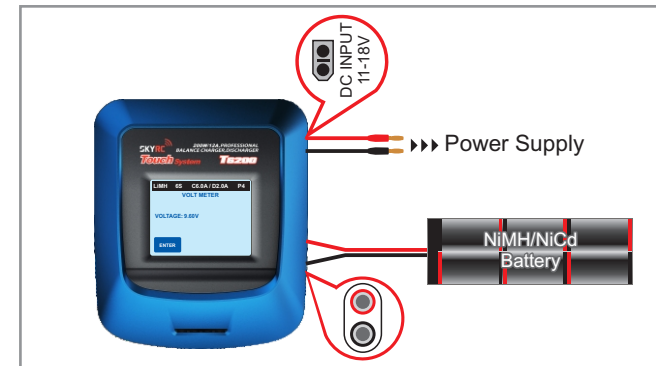

This diagram shows the correct way to connect your battery to check the voltage.

## MOTOR RPM TESTER

Users connect the sensor motor and charger with sensor wire, set the pulse width and test the RPM of the motor. Please do as follows,

1. Connect the motor and ESC.
2. Switch off the ESC and connect it to the battery.
3. Connect the power to the charger.
4. Insert the ESC signal wire to ESC port in the charger.
5. Connect the motor and charger with motor sensor wire. There is a motor sensor port beside the temp sensor.
6. Enter Motor RPM Tester Program, set the initial pulse width which should be the same as the neutral position of the transmitter. We suggest to set it to 1480 as most of the transmitters' neutral position is like that.

Touch start button or touch and hold "MOTOR" for 3 seconds to enter motor RPM tester.

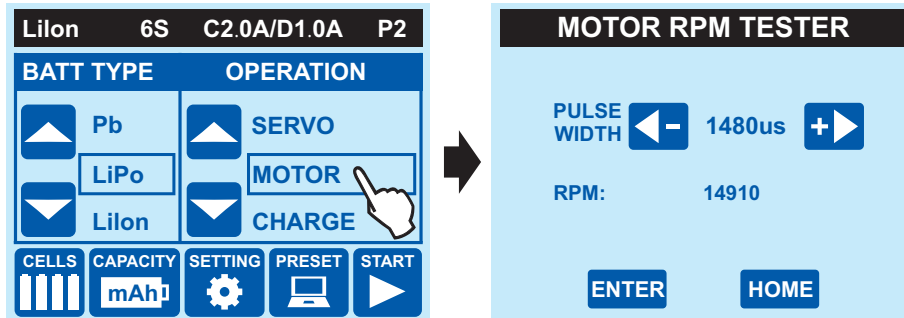

7. Switch on the ESC. Touch  $\leftarrow$  /  $\rightarrow$  to change the value of pulse width and check the RPM of the motor corresponding to different pulse width. If the motor doesn't run, please recheck the transmitters' neutral position and reset the initial pulse width.

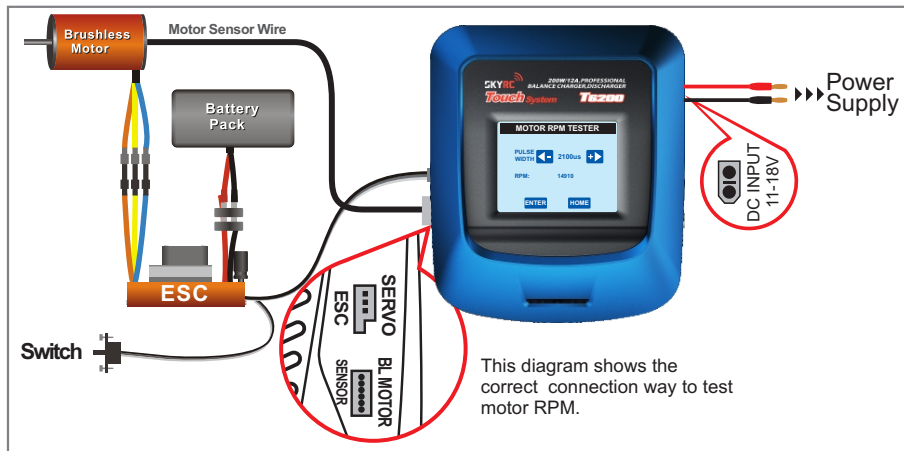

## SERVO TESTER

Connect the servo and the charger with wire, change the pulse width value and check whether the servo works or not. Please do as follows,

1. Connect the battery to the power.
2. Connect the servo to the servo port in left side of the charger. Be careful with the correct polarity.
3. Enter to Servo Tester Program in the charger, change the pulse width and check the response of the servo.

Touch start button or touch and hold "SERVO" for 3 seconds to enter servo tester.

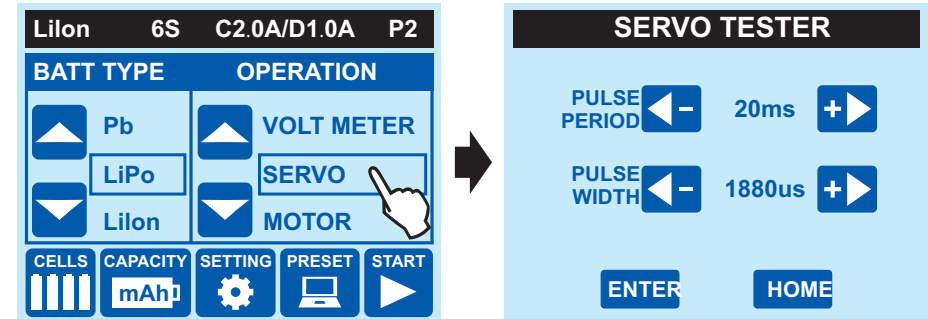

Touch  $\leftarrow$  /  $\rightarrow$  to change the value of pulse period depending on different servos.

Touch  $\leftarrow$  /  $\rightarrow$  to change the value of pulse width and observe the response of the servo corresponding to different pulse width.

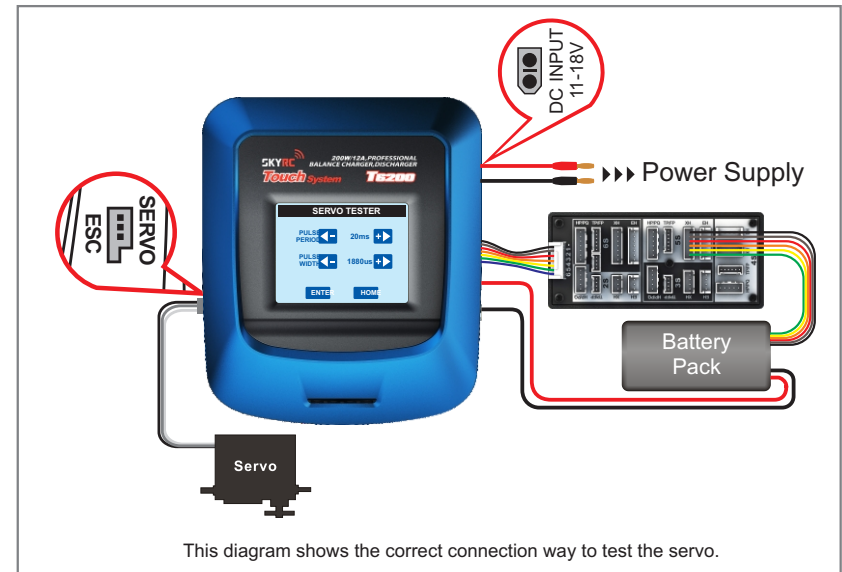

MEMORY PRESET-DATA STORE/LOAD

The charger can store up to 5 different charge/discharge profiles for your convenience, and the stored profiles can be recalled quickly without having to go through the setup process.

1. EDIT AND BACK

Touch "EDIT" to set the profiles and "HOME" to homepage.

Touch "CONFIRM" to confirm the setting and go back to previous screen.

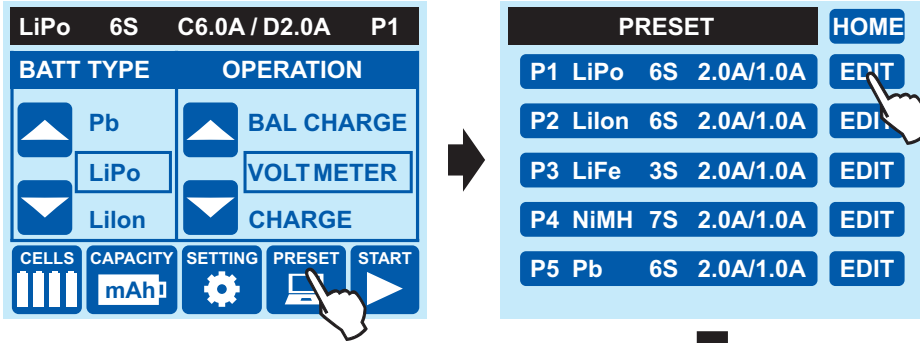

**NOTE:**  
Please touch ">" to change the battery type and operation program.  
Please touch "-" and "+" to get the right battery cells count and desired charge/discharge current.

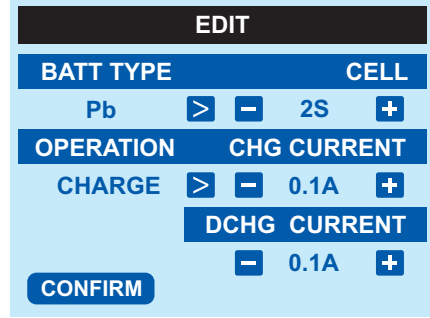

2. CALL OUT

The basic settings of the profiles are displayed and you could touch the settings bar to enter to the homepage. All the current settings will displayed in the top of the screen. please touch and hold the desired operation program to start the progress.

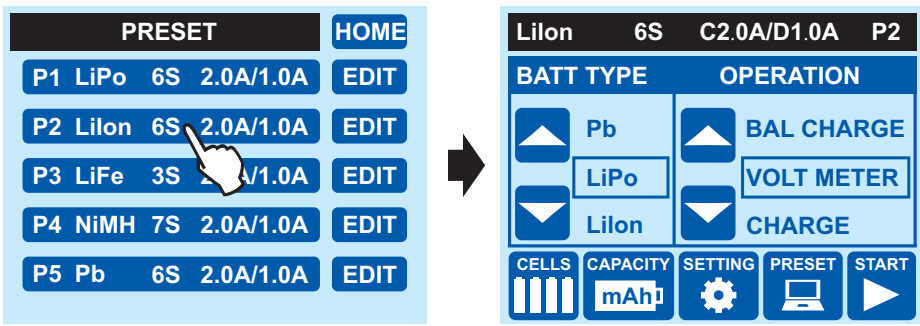

SETTING

You could do SYSTEM SETTING, SAFETY PROTECTION and CHARGER PARAMETER settings when you enter to Setting program.

Please touch "◀" and "▶" to go to previous or next setting phase and touch "NEXT" to enter to current setting program.

1. SYSTEM SETTING

ITEM	SELECTION	DESCRIPTION
KEY BEEP	ON/OFF	The beep sounds at every time touching the screen to confirm your action. The beep or melody sounded at various times during operation to alert different mode changes.
BUZZER	ON/OFF	
LCD LIGHT	1-5	The brightness of the LCD can be adjusted basing on personal preference.
THEME	BLUE, RED, YELLOW, GREEN	Different color theme can be selected basing on personal preference.
ABOUT	—	System information: model no., serial no., hardware version, software version.

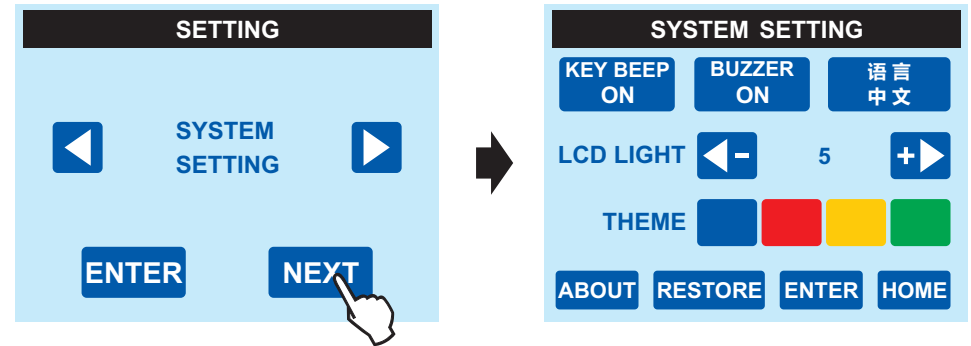

Please touch the referred setting(selections) to change it.

When touching "RESTORE" the charger will restore factory default settings.

2. SAFETY PROTECTION

ITEM	SELECTION	DESCRIPTION
CAPACITY CUT OFF	OFF 100-20000 mAh	This program sets the maximum charge capacity that will be supplied to the battery during charge. If the delta peak voltage is not detected nor the safety timer expired by any reason, this feature will automatically stop the process at the selected capacity value.
SAFETY TIME	OFF 1-720 Min	When you start a charge process, the integral safety timer automatically starts running at the same time. This is programmed to prevent overcharge the battery if it proves to be faulty, or if the termination circuit cannot detect the battery full. The value for the safety timer should be generous enough to allow a full charge of the battery.
TEMP CUT OFF	20°C/68°F - 80°C/176°F	The battery's internal chemical reaction will cause the temperature of the battery to rise. If the temperature limit is reached, the process will be terminated.

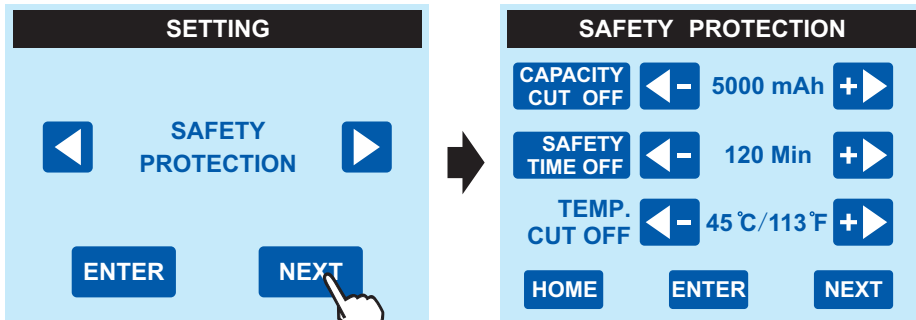

Please touch **CAPACITY CUT OFF** and **SAFETY TIME OFF** screen to make the functions ON or OFF. And touch “◀” and “▶” to get the proper parameter.

NOTE: The TEMP CUT OFF function can not be OFF.

3. CHARGER PARAMETER

ITEM	SELECTION	DESCRIPTION
TERMINAL VOLTAGE CONTROL (TVC)*	LiPo 4.18-4.3V/Cell	This is the voltage level that T6200 will stop charging the battery. Intended ONLY for expert users and racers, completely at their own risk, which allows LIPO and LIFE packs to be charged in excess of recommended cell terminal voltages.
	Lilon 4.08-4.2V/Cell	
	LiFe 3.58-3.7V/Cell	
END VOLT DISCHARGE	LiPo 3.0-3.3V/Cell	This is the voltage level that T6200 will stop discharging the battery, and is shown as volts PER CELL in the pack (not total pack voltage).
	Lilon 2.9-3.2V/Cell	
	LiFe 2.6-2.9V/Cell	
	NiMH 0.1-1.1V/Cell	
	NiCd 0.1-1.1V/Cell	
	Pb 1.8V/Cell	
REST TIME	1-120 min	The battery is on the cyclic process of charge and discharge can often become warm after charge or discharge period. The program can insert a time delay to occur after each charge and discharge process to allow the battery adequate time to cool down before being subjected to the next process.

\*WARNING! By setting the TVC to any POSITIVE SETTING above default value, you ACCEPT ALL RESPONSIBILITY for DAMAGE to your battery, FIRE, INJURY, and any other loss which may result. If you do not agree to accept all risk, DO NOT OPERATE YOUR CHARGER UNLESS ALL TVC POSITIONS ARE SET TO DEFAULT VALUE!

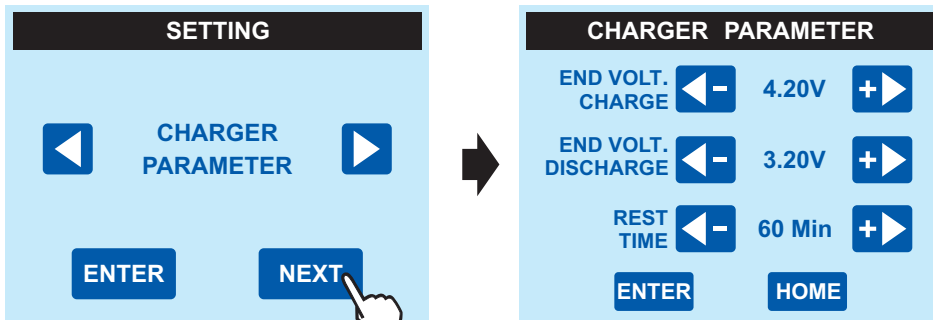

Please touch “◀” and “▶” to get the proper parameter.

ERROR MESSAGE

It incorporates a variety of functions for the systems to verify processes and the state of the electronics. In case of an error the screen will display the cause of error and emit an audible sound.

ERROR MESSAGE	EXPLANATION
"INT. TEMP TOO HIGH"	The internal temperature of the unit goes too high.
"EXT. TEMP TOO HIGH"	The external temperature of the unit goes too high.
"DC IN TOO LOW"	Input voltage less than 11V.
"DC IN TOO HIGH"	Input voltage higher than 18V.
"OVER TIME LIMIT"	The charging time is longer than the maximum charging time which the user sets.
"OVER CAPACITY LIMIT"	The battery capacity is more than the maximum capacity which the user sets.
"REVERSE POLARITY"	Incorrect polarity connected.
"CONNECTION BREAK"	The battery is interrupted.
"CELL NUMBER ERROR"	The cell number is wrong.
"BALANCE CONNECTER ERROR"	The balance connect is wrong.
"NO BATTERY"	There is no battery connecting to the charger.
"CONNECTION ERROR"	The Battery connection is wrong.
"BATTERY WAS FULL"	The battery voltage is higher than the maximum voltage which the user sets when charging in balance mode.

SPECIFICATION

Input	DC 11-18Volt
Charge Circuit Power	200W
Charge Current Range	0.1-12.0A
Discharge Circuit Power	40W
Discharge Current Range	0.1-5.0A
Current Drain for Balancing Port	200mA/cell
NiCd/NiMH Battery Cell Count	1-15Cells
LiPo/LiFe/Lilon Cell Count	1-6Cells
Pb Battery Voltage	2-20V
Net Weight	560g
Dimension	140x165x60mm

THE SET CONTAINS

1. SKYRC T6200 Charger
2. Multiple Balancing Board
3. 18AWG Wire Charging Cable
4. DC Input Cable



RECOMMENDED ACCESSORIES



Efuel 20A Power Supply  
SK-200014



Efuel 30A Power Supply  
SK-200013



Temperature Probe with Magnet  
SK-600005-01

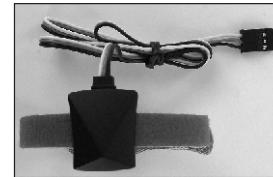

Temperature Probe  
SK-600040-01

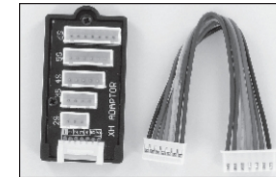

XH Adaptor  
SK-600020-04



HP/PQ Adaptor  
SK-600016-03

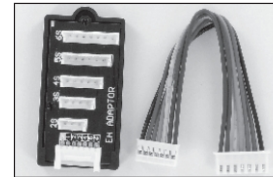

EH Adaptor  
SK-600014-01

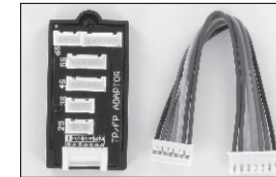

TP/FP Adaptor  
SK-600018-02



Tamiya charging cable  
5201-0030-01

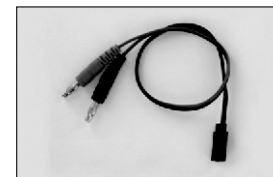

Futaba RX charging cable  
5201-0044-01



Glow charging cable  
5201-0045-01



Crocodile clip charging cable  
5201-0031-01



JST/BEC charging cable  
5201-0043-01



EC3 charging cable  
5201-0034-01

## CONFORMITY DECLARATION

SKYRC T6200 satisfies all relevant and mandatory EC directives and FCC Part 15 Subpart B: 2008.

The product has been tested to meet the following technical standards:

	Test Standards	Title	Result
CE-EMC	EN 61000-6-3	Electromagnetic compatibility (EMC) -- Part 6-3: Generic standards - Emission standard for residential, commercial and light-industrial environments	Conform
	EN 61000-6-1	Electromagnetic compatibility (EMC) Part 6-1: Generic standards Immunity for residential, commercial and light-industrial environments	Conform
	EN 55014-1	Electromagnetic compatibility - Requirements for household appliances, electric tools and similar apparatus -- Part 1: Emission	Conform
	EN55014-2	Electromagnetic compatibility - Requirements for household appliances, electric tools and similar apparatus - Immunity - Product family standard	Conform
FCC	FCC Part 15	Electromagnetic compatibility (EMC), Conduction Emission & Radiation Emission.	Conform



This symbol means that you must dispose of electrical devices from the General household waste when it reaches the end of its useful life. Take your charger to your local waste collection point or recycling centre. This applies to all countries of the European Union, and to other European countries with a separate waste collection system.

## LIABILITY EXCLUSION

This charger is designed and approved exclusively for use with the types of battery stated in these Instruction Manual. SKYRC accepts no liability of any kind if the charger is used for any purpose other than that stated. We are unable to ensure that you follow the instructions supplied with the charger, and we have no control over the methods you employ for using, operating and maintaining the device. For this reason we are obliged to deny all liability for loss, damage or costs which are incurred due to the incompetent or incorrect use and operation of our products, or which are connected with such operation in any way. Unless otherwise prescribed by law, our obligation to pay compensation, regardless of the legal argument employed, is limited to the invoice value of those SKYRC products which were immediately and directly involved in the event in which the damage occurred.

## WARRANTY AND SERVICE

We guarantee this product to be free of manufacturing and assembly defects for a period of one year from the time of purchase. The warranty only applies to material or operational defects, which are present at the time of purchase. During that period, we will repair or replace free of service charge for products deemed defective due to those causes.

You will be required to produce proof of purchase (invoice or receipt). This warranty is not valid for any damage or subsequent damage arising as a result of misuse, modification or as a result of failure to observe the procedures outlined in this manual.